

透科自动化

User Manual

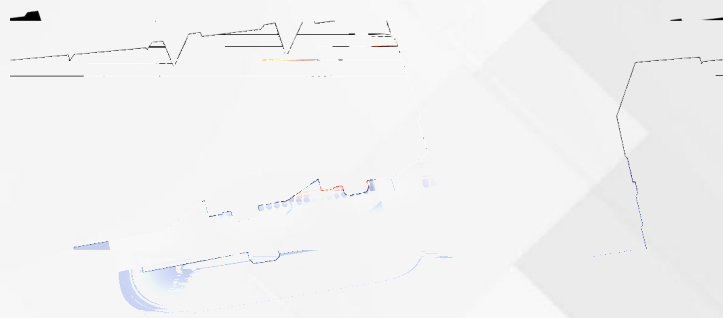

**RX**

ETHERNET IP

Remote IO

IO

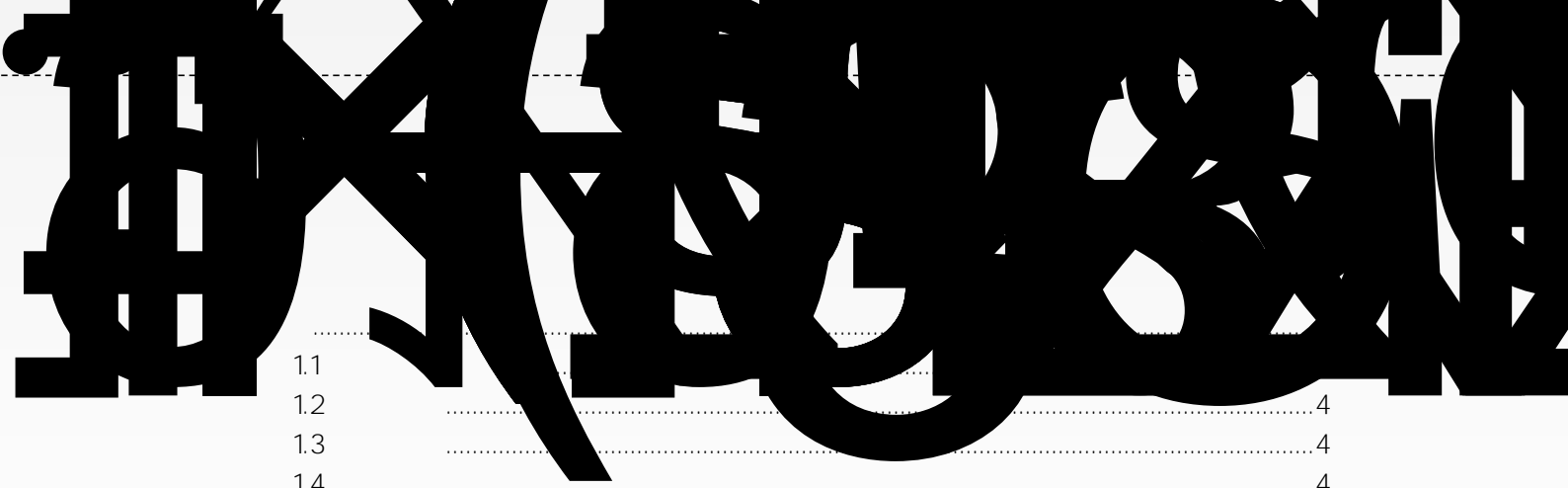

1.1	.....	4
1.2	.....	4
1.3	.....	4
1.4	.....	4
2.	.....	5
2.1	.....	6
2.2 <del>510E</del> EP	.....	8
2.3 DI	.....	8
2.4 DQ	.....	8





0 9 n

(Ethernet/IP) ODVA

0 9 n





E	

1	
2	
3	
4	
8	

1	PNP or NPN
	PNP
2	NPN

И И

R51C1-EP/F

DI 3

1		16
2		2 bytes
3	Ton	Type. 18uS / Max. 35uS
4	Toff	Type. 135uS / Max. 250uS
5		
6		
7		24 V DC (-15 %/+ 20 %), (IEC 61131-2, type 2)
8	"0"	-3...+5 V (IEC 61131-2, type 2)
9	"1"	15...30 V (IEC 61131-2, type 2)
10		Typ. 10mA/Ch (IEC 61131-2, type 2)
11		/ 500V DC

MOSFET DQ 4

1		12
2		2 bytes
3	Ton	Type. 12uS / Max. 25uS
4	Toff	Type. 10mS / Max. 20mS ( )
5		
6		
7		
8		24 V DC (-15 %/+ 20 %), (IEC 61131-2, type 2)
9		Max. 0.5 A /Ch,
10		6A
11		2 2-Pin



ETHERNET IP

5

1		ETHERNET IP
2		10/100 Mbaud
3		RJ45 IEEE 802.xx
5		MAC
6		CAT5e
7	ETHERNET IP	(MRP)
8		1500V DC IEC61000-4-2

R51C1-EP/F

R51C1-EP/Pro

1		DC 5V
2		1.5A
3		7

3

MOSFET

3

24V DC (-15 %/+ 20 %) 0.5A

I/O

500V DC

24V DC (-15 %/+ 20 %) 16\*10mA I/O

500V DC

MOSFET

24V DC (-15 %/+ 20 %) 8\*0.5A

I/O

500V DC



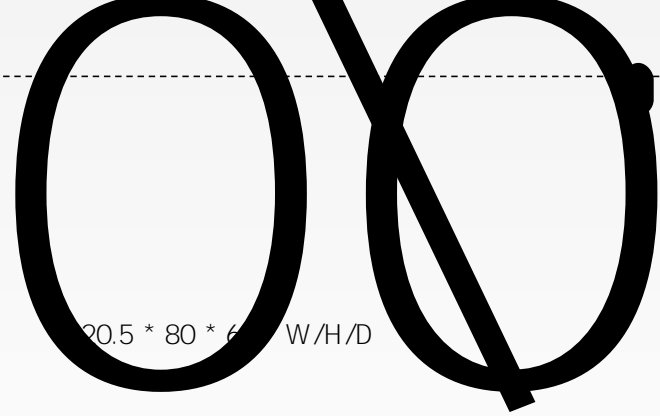
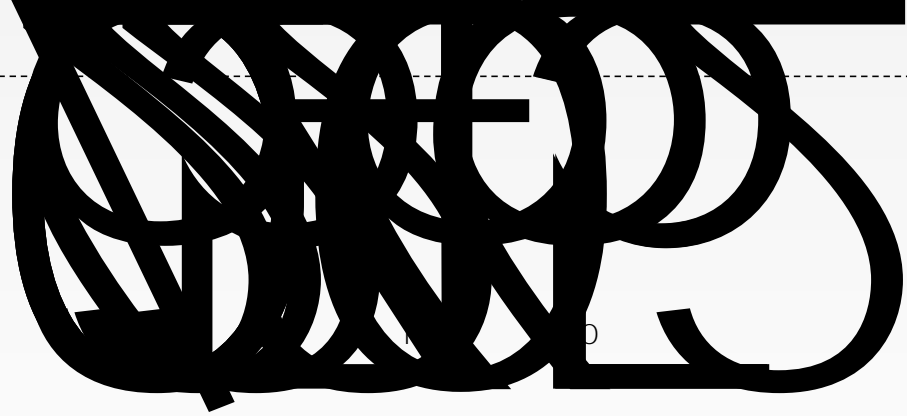

20.5 \* 80 \* 6 W/H/D

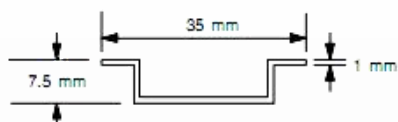





---

	1	0	1	2	3	4	5
IM0	0.0	.1	.2	.3	.4	.5	

	1	0	1	2	3	4	5
IM0	0.0	.1	.2	.3	.4	.5	

IM1 1.0 .1 .2 .3 .4 .5

PE	COM1	V1	I1	COM2	V2	I2	NC
NC	COM3	V3	I3	COM4	V4	I4	NC

CH2

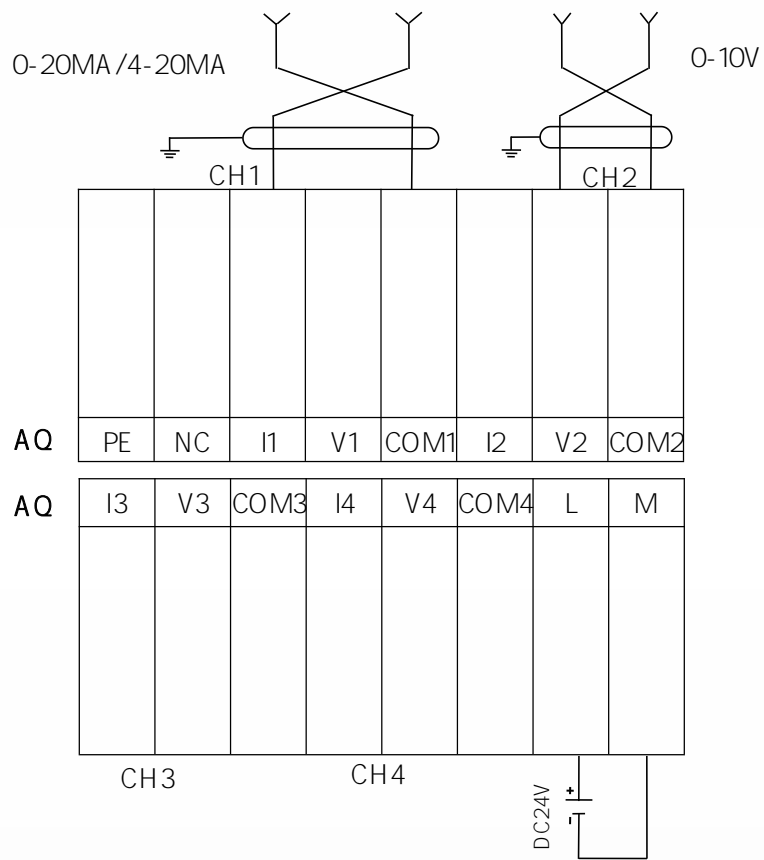



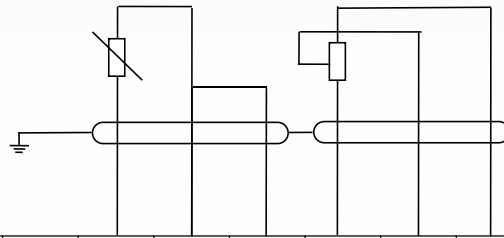

RTD

		1A	1B	1C	2A	2B	2C
PE	NC	1A	1B	1C	2A	2B	2C

RTD

		3A	3B	3C	4A	4B	4C
		3A	3B	3C	4A	4B	4C

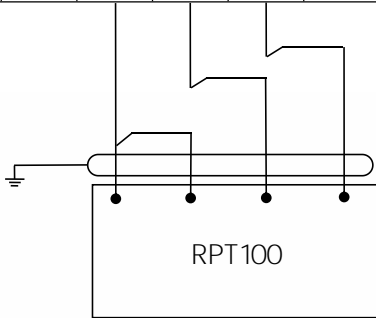

RPT100



RJ45

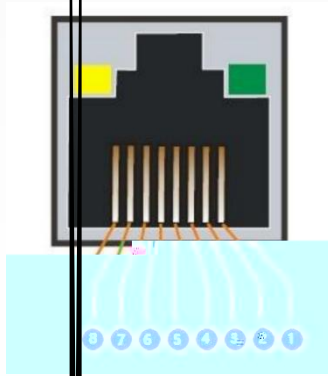

1	TD+	
2	TD-	
3	RD+	
4	NC	
5	NC	
6	RX-	
7	NC	
8	NC	

LED

3

I/O

RJ45



“1” / / LED “0” n /

RJ45

RJ45

Hub

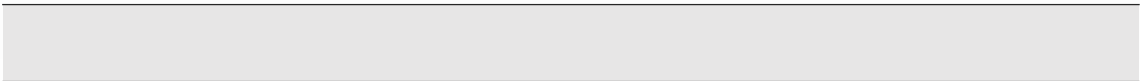
9 9 RJ45



RJ45

RJ45

RJ45

RJ45



IM1 <sup>(*)</sup>	DI 1	IM2 <sup>(*)</sup>	DI 2
0	DI-0.0	0	DI-1.0
1	DI-0.1	1	DI-1.1
2	DI-0.2	2	DI-1.2
3	DI-0.3	3	DI-1.3
4	DI-0.4	4	DI-1.4
5	DI-0.5	5	DI-1.5
6	DI-0.6	6	DI-1.6
7	DI-0.7	7	DI-1.7

\* M1 M2

10P

12

16P

0.5A

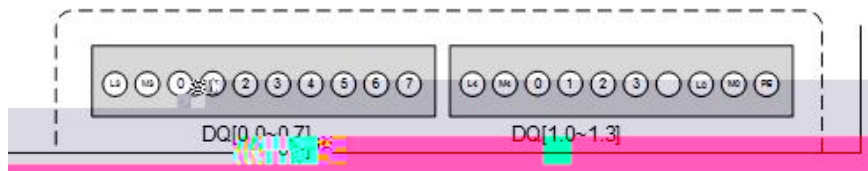

L3 <sup>(*)</sup>	DQ	L4 <sup>(*)</sup>	DQ
IM3 <sup>(*)</sup>	DQ	IM4 <sup>(*)</sup>	DQ
0	DQ -0.0	0	DQ -0.0
1	DQ -0.1	1	DQ -0.1
2	DQ -0.2	2	DQ -0.2
3	DQ -0.3	3	DQ -0.3
4	DQ -0.4		
5	DQ -0.5	24V	0
6	DQ -0.6	0V	
7	DQ -0.7	PE	

\* L3/M3 L4/M4

DQ

24V





R51C1-EP/F R51C1-EP/Pro DI/DQ

- 16                                    2    In
- 12                                    2    Out

E10C1	12		2	In	
E20C1	12		2	Out	
E3041	4			2	8
In					
E4041	4			2	8
Out					

AB

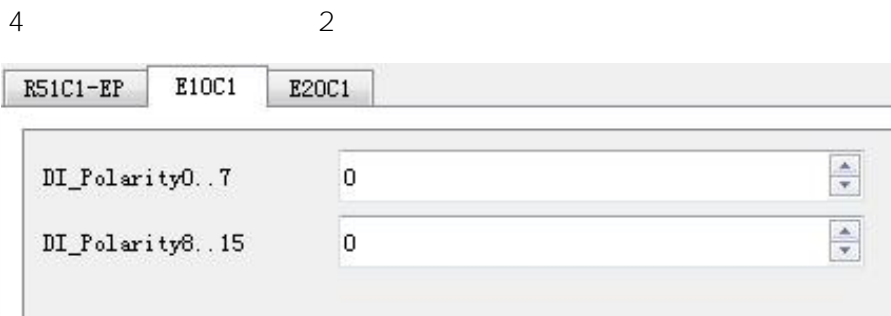

DI_Polarity 0..7	DI[7..0]		0~ 255	DI-0.0	Bit0 "0"
DI_Polarity 8..15	DI[15..8]		0~ 255	Polarity[7..0] "4" "DI-0.2"	bit "1" 0000 0100B







CHx_Measuring_Range	"Voltage +/- 10V"	Disable
	"Voltage +/- 5V"	
	"Voltage +/- 2.5V"	
	"Voltage 0 to 10V"	
	"Voltage 0 to 5V"	
	"Current +/- 20mA"	
	"Current 0 to 20mA"	
	"Current 4 to 20mA"	
	"Disable"	
Voltage +/- 10V		
CHx_Offset	0-65536	Vi = Vr * Gain/1000 + Offset
	0	
CHx_Gain	0-65536	Vi Vr
	m	

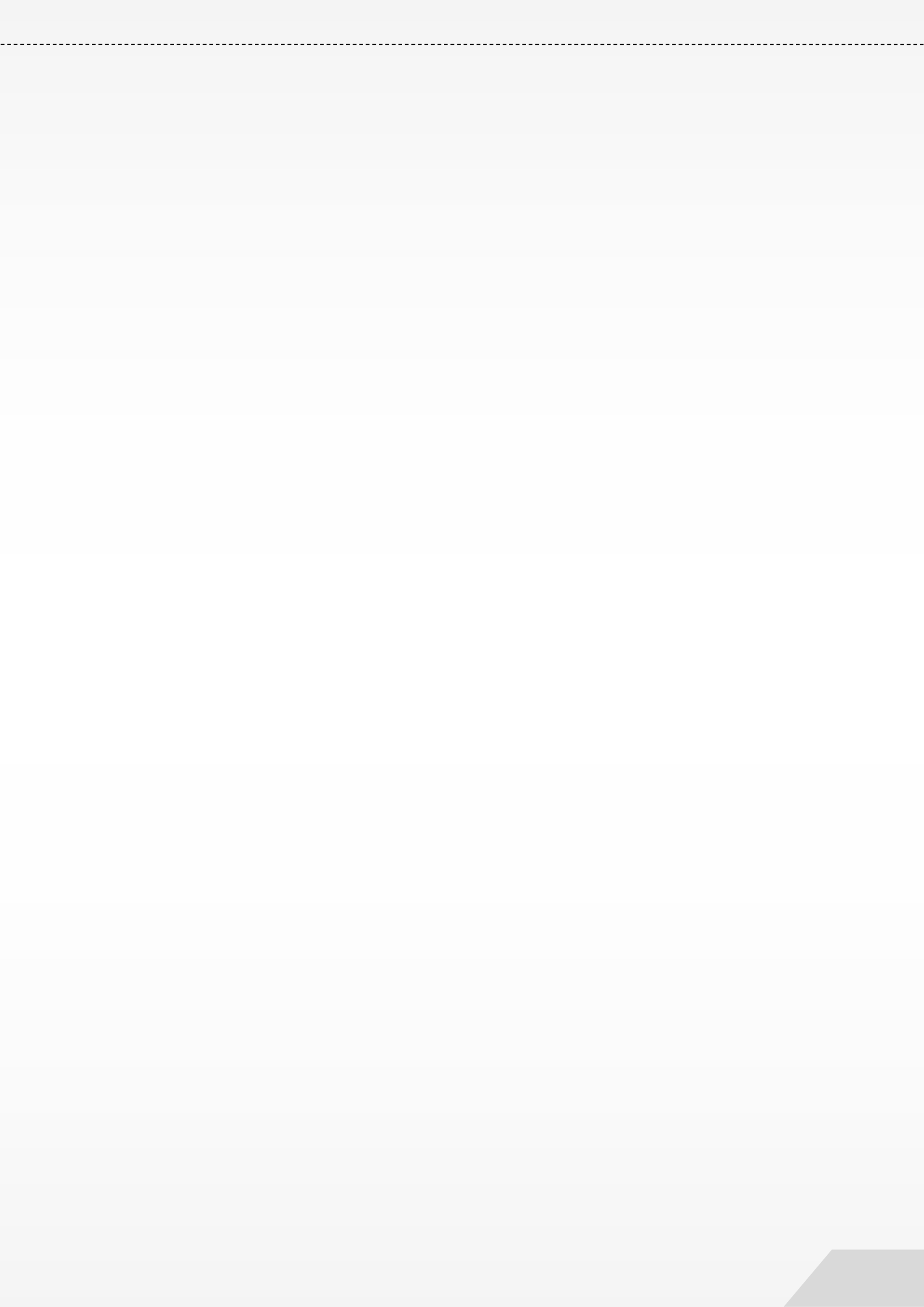

12bit ADC          4bit          "0"

	-/+ 10V	-/+ 5V	-/+ 2.5V	0-10V	0-5V	-/+ 20Ma	0-20Ma	4-20Ma
	32000	32000	32000	65520	65520	32000	65520	65520
0	0	0	0	0	0	0	0	0
	-32000	-32000	-32000			-32000		

E3041 12BIT

CH1\_Output\_Range "Voltage +/-10V"

CH1\_Offset 100 DEC

CH1\_Gain 2000 DEC

1 -2.5V  
 -2.5V - 8000 = (-32000/-10V)\*-2.5

$$V_i = V_r * \text{Gain} / 1000 + \text{Offset}$$

-16100 DEC

C11C H

E3041 12BIT

CH2\_Output\_Range "Current 4 to 20mA"

CH2\_Offset 100 DEC

CH2\_Gain 500 DEC

2 10mA  
 10mA 32500 = (65000/20mA)\*10mA

$$I_i = I_r * \text{Gain} / 1000 + \text{Offset}$$

16350 DEC

3FDE H

Param_list	
------------	--

Param_Offset	
Param_Gain	
Param_Error_Mode	"0" "1"
Param_Error_Value	

1. 0 Voltage +/-10V

CHx_Measuring_Range			0- "Voltage 0- 10V" 1- "Current 0 to 20mA" 2- "Current 4 to 20mA" 255-"Disable" Voltage 0- 10V	Disable

2. 0x0

8021:0	Param_Offset	RO
8021:01	CH1_Offset	RW P
8021:02	CH2_Offset	RW P
8021:03	CH3_Offset	RW P
8021:04	CH4_Offset	RW P

3. 1000 1

8022:0	Param_Gain	RO
8022:01	CH1_Gain	RW P
8022:02	CH2_Gain	RW P
8022:03	CH3_Gain	RW P
8022:04	CH4_Gain	RW P

16bit

16bit

12bitADC

4bit

"0"

	0~ 10V	0- 20mA	4- 20mA
	32500	32500	32500
0	0	0	0

ETHERNET IP

EDS

R51C1\_EPeds

EDS

- "R51C1-EP"

IO

R51C1-EP/F

R51C1-EP/Pro



